

SHINHAN C.M



Introduction

Founded in 2004, Shinhan C.M is a company specializing in manufacturing containers for color cosmetics. We have been steadily growing in the rapidly changing market. Pursuing constant challenges and changes, all members of Shinhan C.M communicate fearlessly and faithfully perform their roles based on strong trust. Thus, Shinhan C.M. has been able to become an important partner for numerous cosmetic brands over the past 20 years.

Based on the spirit of '**Endow values and sensitivity to makeup**', we are still with our customers on their journey to create better value.

We are constantly developing various products that have not been seen before in the market. Also, we are further raising the level beyond maintaining the current high quality and stable production capacity.

These persistent efforts are our duty for all customers who trust Shinhan C.M. We will do our best for sustainable growth and we hope that the results of the growth will contribute to the happiness of all members in Shinhan C.M and further to the local community.

Please look forward to us who are not complacent in the present, challenging and paving own way.

History

- 2024 – Expansion and Relocation of new headquarters
- 2021 – Acquired ISO 9001 quality system certification
- 2016 – Move to new factory
- 2014 – Registered R&D department (KOITA)
- 2013 – Registered as a venture company
- 2012 – Transitioned SHINHAN C.M to a corporation company
- 2011 – Registered 5 patents & a utility model
- 2009 – Move to new factory
- 2008 – Registered 2 cases of patents
- 2004 – Founded SHINHAN C.M



Mission

We realize customer value with the best products and services.

We feel pleasure and rewarded when our customers achieve satisfactory results through collaboration with us.

Thankfully, the fact that many customers work with us means that we are recognized as an indispensable partner in the market. To repay that, we make it a top priority to provide the best products and services.

Endow values and sensitivity to makeup

We become a global market leader based on trust, flexibility, and innovation.

We imagine the 1st position in the world in the same line of business. As we constantly strive for customer satisfaction and continue to pioneer new markets.

It is clear that one day we will become a global market leader.

Vision



Core Value

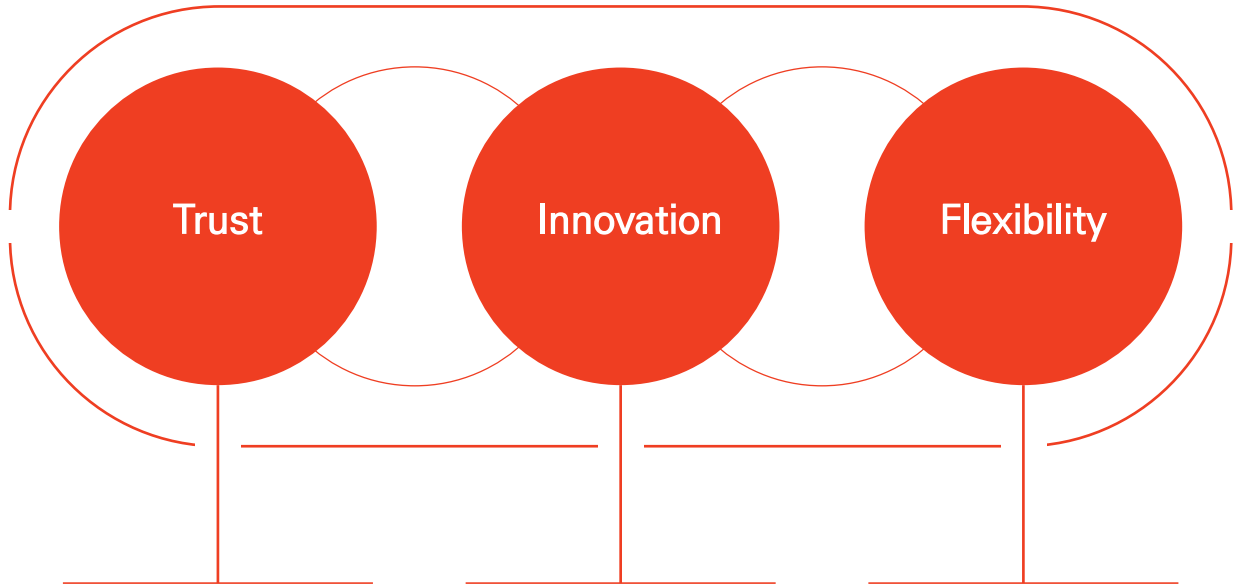

Trust

We operate our business honestly and openly in the relationship with our customers and partners.

Innovation

We firmly achieve innovation through all members' passion for work, deep thinking, and willingness to challenge. Also, we take failure as an opportunity for learning and growth.

Flexibility

We cannot survive in the market if we remain unchanged. With this sense of crisis, we always pursue flexible thinking and proactive change.



SHT-01

SIZE 25mm x 25mm x 75.6mm
VOLUME 4.5ml
MATERIALS ABS, PETG

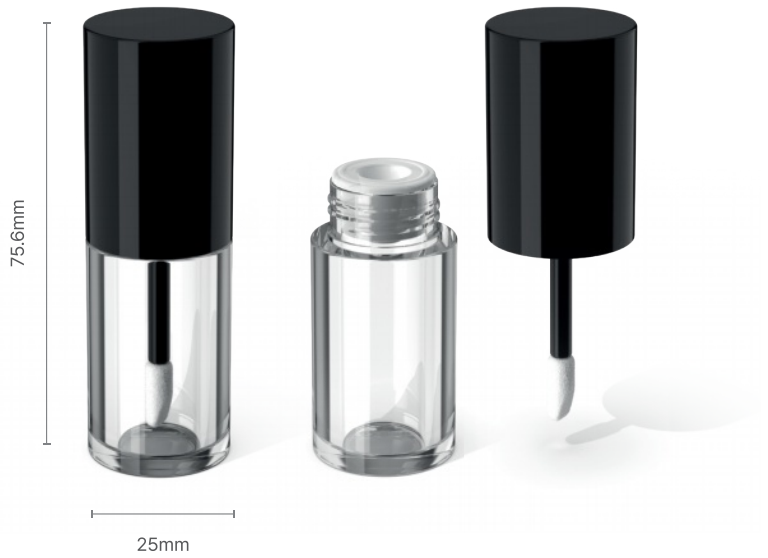

SHT-01-1

SIZE 25.2mm x 25.2mm x 81.3mm
VOLUME 4.5ml
MATERIALS ABS, PETG



SHT-02

SIZE 51.1mm x 15mm x 80.3mm
VOLUME 6.5ml
MATERIALS ABS, SURLYN



SHT-03

SIZE 20.5mm x 20.5mm x 95.2mm
VOLUME 4.5ml
MATERIALS ABS, PETG



SHT-03-01

SIZE 20.5mm x 20.5mm x 84.7mm
VOLUME 4.5ml
MATERIALS ABS, PETG



SHT-03-02

SIZE 20.5mm x 20.5mm x 86.9mm
VOLUME 4.5ml
MATERIALS ABS, PETG

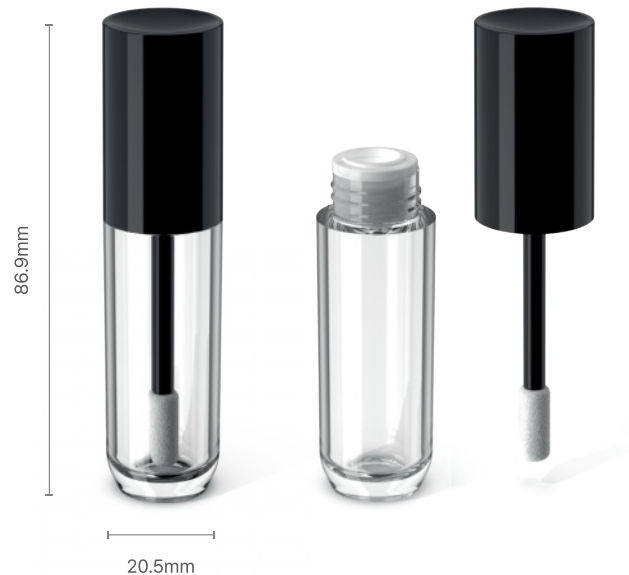

SHT-03-03

SIZE 20.5mm x 20.5mm x 84.9mm
VOLUME 4.5ml
MATERIALS PETG

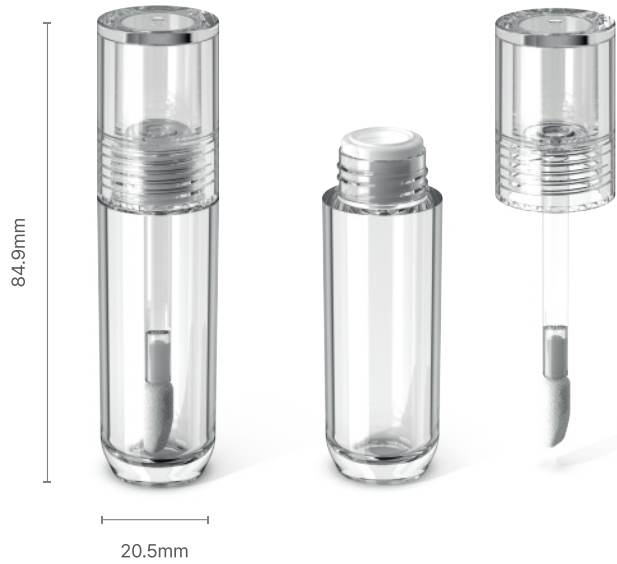

SHT-04

SIZE 17.7mm x 17.7mm x 73.7mm
VOLUME 5ml
MATERIALS ABS, PETG



SHT-05

SIZE 17.7mm x 17.7mm x 86.1mm
VOLUME 5ml
MATERIALS ABS, PETG



SHT-06

SIZE 17.4mm x 17.4mm x 104.7mm
VOLUME 4.5ml
MATERIALS PETG

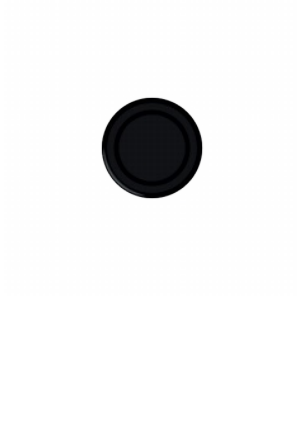

SHT-07

SIZE 17.4mm x 17.4mm x 115.2mm
VOLUME 4.5ml
MATERIALS PETG

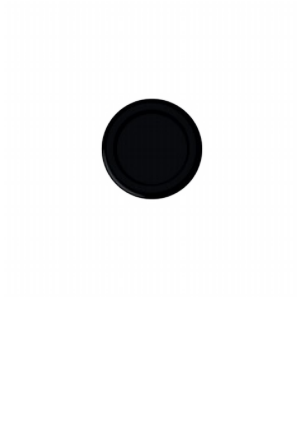

SHT-08

SIZE 16.4mm x 16.4mm x 123.3mm
VOLUME 2.5ml
MATERIALS ABS, PETG

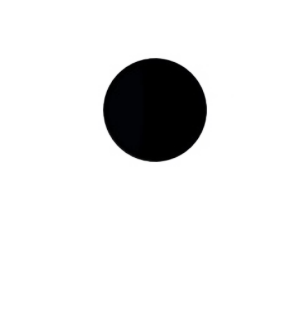

SHT-09

SIZE 16.4mm x 16.4mm x 123.5mm
VOLUME 2.5ml
MATERIALS ABS, PETG

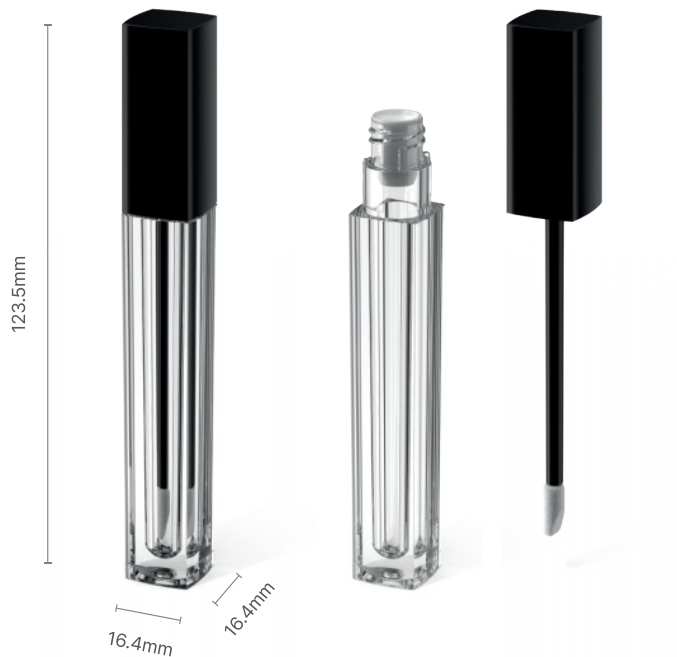

SHT-10

SIZE 19.9mm x 19.9mm x 75mm
VOLUME 4ml
MATERIALS PETG

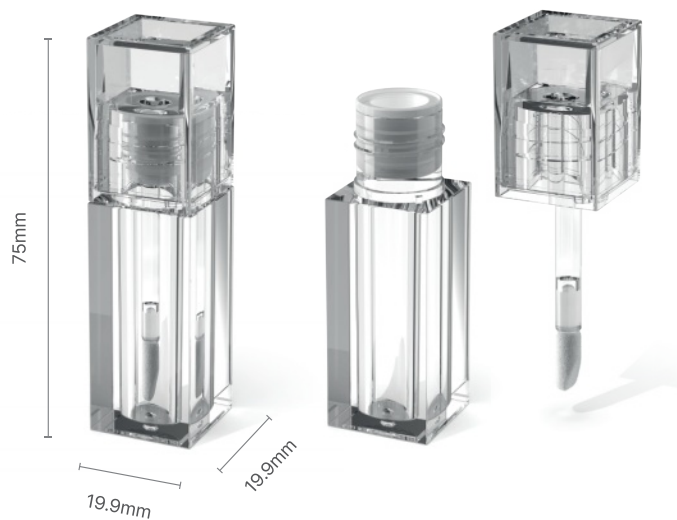

SHT-11

SIZE 23mm x 23mm x 73.8mm
VOLUME 6ml
MATERIALS ABS, PETG



SHT-11-01

SIZE 23mm x 23mm x 73.8mm
VOLUME 6ml
MATERIALS ABS, PETG



SHT-12

SIZE 19.8mm x 19.8mm x 74.9mm
VOLUME 4.5ml
MATERIALS ABS, PETG



SHT-12-01

SIZE 19.8mm x 19.8mm x 75mm
VOLUME 4.5ml
MATERIALS ABS, PETG



SHT-13

SIZE 19.8mm x 19.8mm x 82.5mm
VOLUME 5.5ml
MATERIALS ABS, PETG

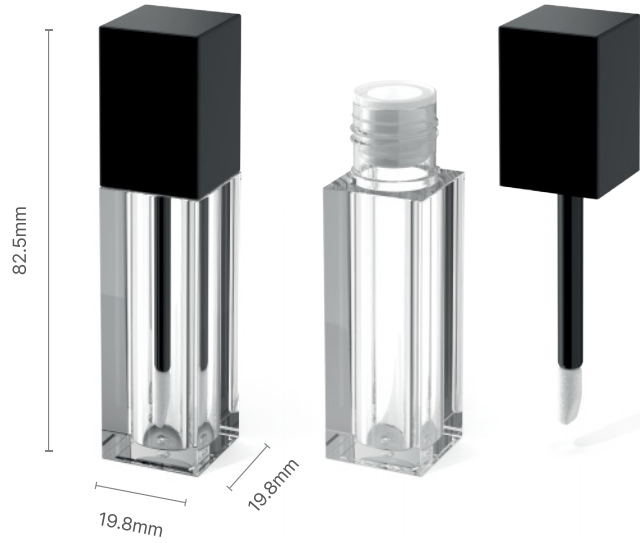

SHT-14

SIZE 19.8mm x 19.8mm x 88.5mm
VOLUME 6ml
MATERIALS ABS, PETG



SHT-15

SIZE 21mm x 21mm x 82.8mm
VOLUME 4.5ml
MATERIALS ABS, PETG



SHT-16

SIZE 19.8mm x 19.8mm x 88.5mm
VOLUME 5.5ml
MATERIALS PETG

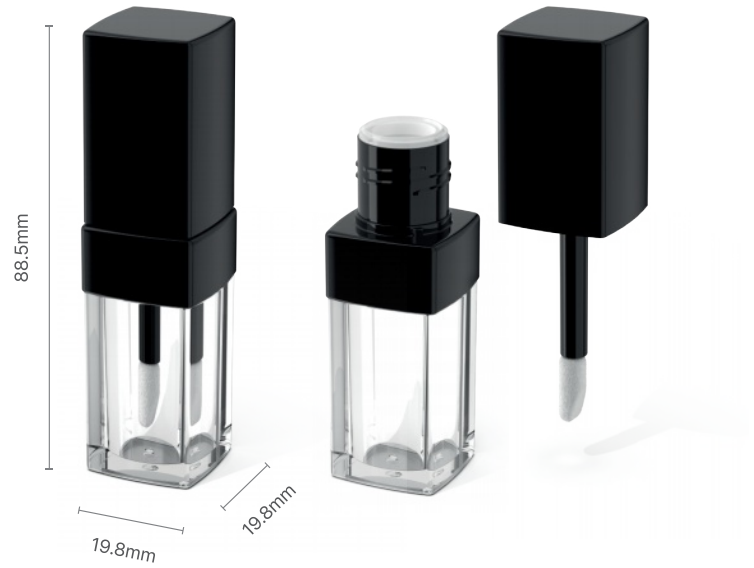

SHT-17

SIZE 18.4mm x 18.4mm x 76.2mm
VOLUME 3.5ml
MATERIALS PETG

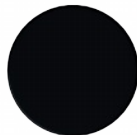

SHT-18

SIZE 18.4mm x 18.4mm x 85.5mm
VOLUME 4ml
MATERIALS PETG



SHT-19

SIZE 18.8mm x 18.8mm x 93.3mm
VOLUME 5ml
MATERIALS ABS, PETG

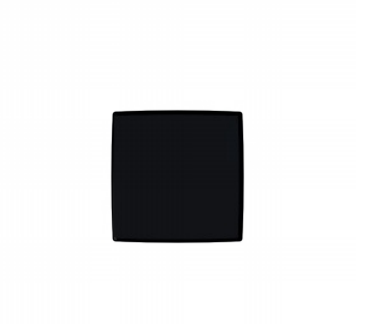

SHT-20

SIZE 22.9mm x 22.9mm x 81.6mm
VOLUME 6ml
MATERIALS ABS, PETG

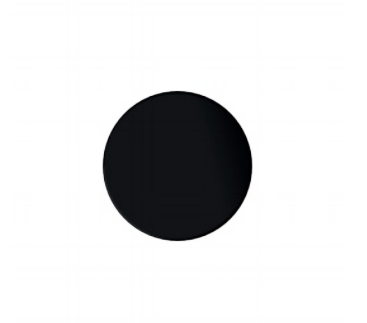

SHT-21

SIZE 15.5mm x 15.5mm x 112.1mm
VOLUME 5ml
MATERIALS PETG



SHT-22

SIZE 16.2mm x 16.2mm x 107.4mm
VOLUME 5ml
MATERIALS PETG

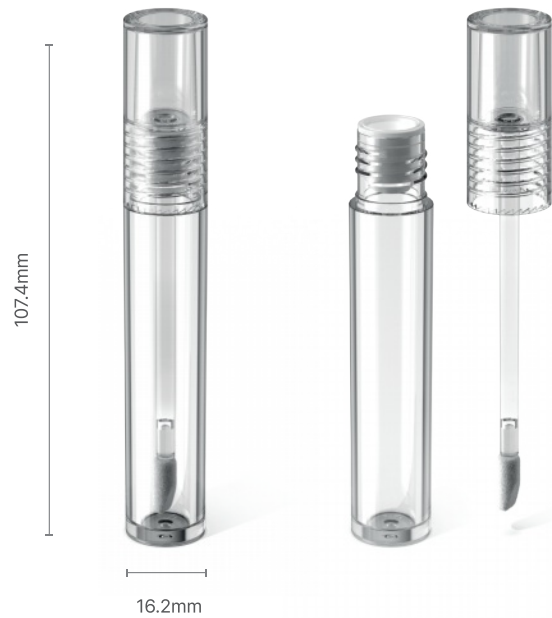

SHT-23

SIZE 19.2mm x 19.2mm x 98.7mm
VOLUME 4.5ml
MATERIALS PETG



SHT-24

SIZE 19.2mm x 19.2mm x 92.3mm
VOLUME 4.5ml
MATERIALS PETG

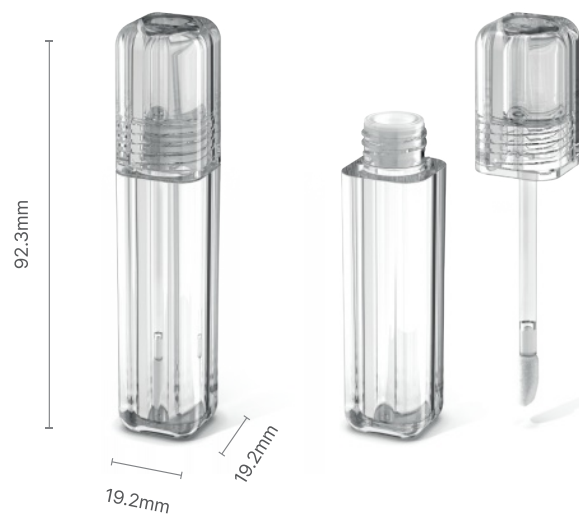

SHT-25

SIZE 25.2mm x 25.2mm x 74mm
VOLUME 4ml
MATERIALS PETG



SHT-26

SIZE 15.7mm x 15.7mm x 108.4mm
VOLUME 4ml
MATERIALS ABS, PETG



SHT-27

SIZE 16.8mm x 16.8mm x 106.4mm
VOLUME 4.5ml
MATERIALS ABS, PETG



SHT-28

SIZE 14.5mm x 14.5mm x 113.3mm
VOLUME 4ml
MATERIALS PETG



SHT-29

SIZE 19.2mm x 19.2mm x 97.1mm
VOLUME 4.5ml
MATERIALS PETG

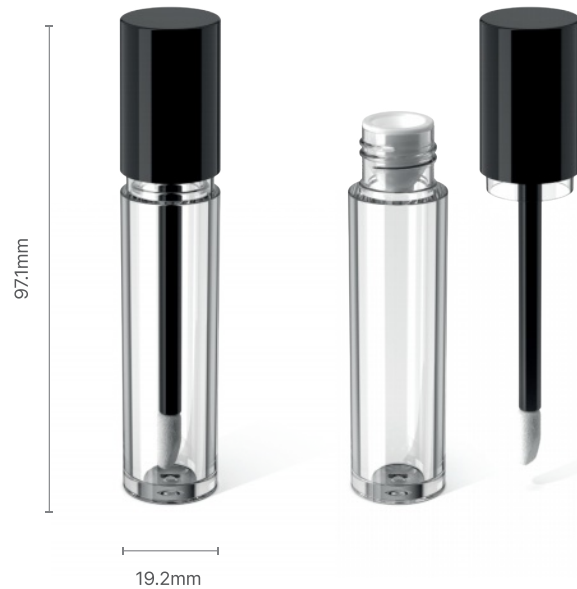

SHT-30

SIZE 18.4mm x 18.4mm x 96.8mm
VOLUME 4.5ml
MATERIALS PETG

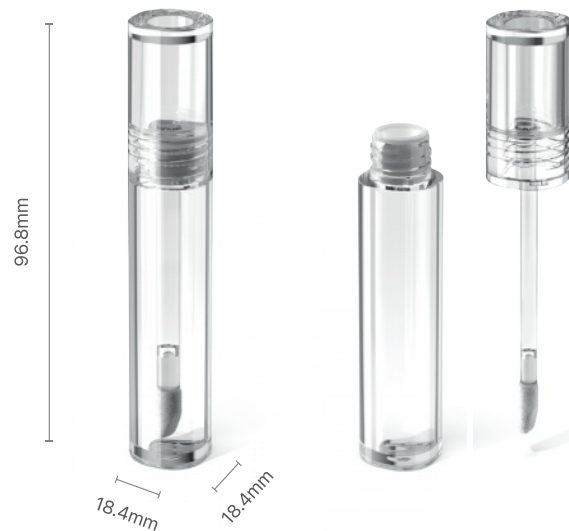

SHT-31

SIZE 16.2mm x 8.5mm x 94.6mm
VOLUME 4.5ml
MATERIALS PETG

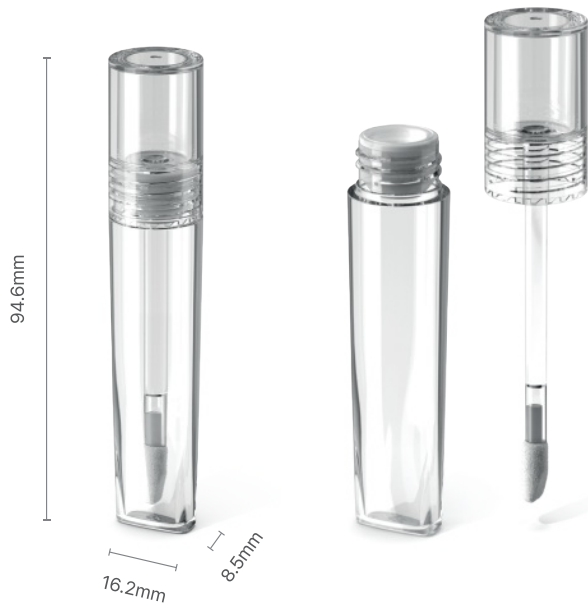

SHT-32

SIZE 17.7mm x 17.7mm x 94.7mm
VOLUME 5ml
MATERIALS PETG

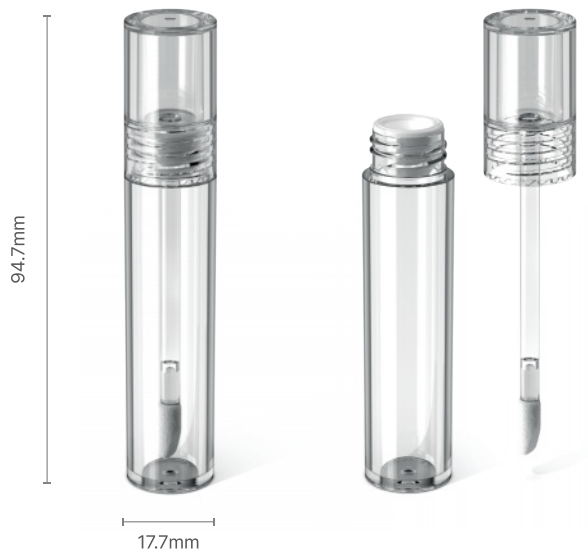

SHT-33

SIZE 16.8mm x 8.5mm x 94.8mm
VOLUME 4ml
MATERIALS PETG



SHT-34

SIZE 17.7mm x 17.7mm x 94.5mm
VOLUME 4.5ml
MATERIALS PETG



SHT-35

SIZE 19.3mm x 19.3mm x 92.5mm
VOLUME 5ml
MATERIALS ABS, PETG



SHT-36

SIZE 18mm x 18mm x 96.5mm
VOLUME 4.5ml
MATERIALS PETG



SHT-37

SIZE 19.2mm x 19.2mm x 95.9mm
VOLUME 5ml
MATERIALS PETG

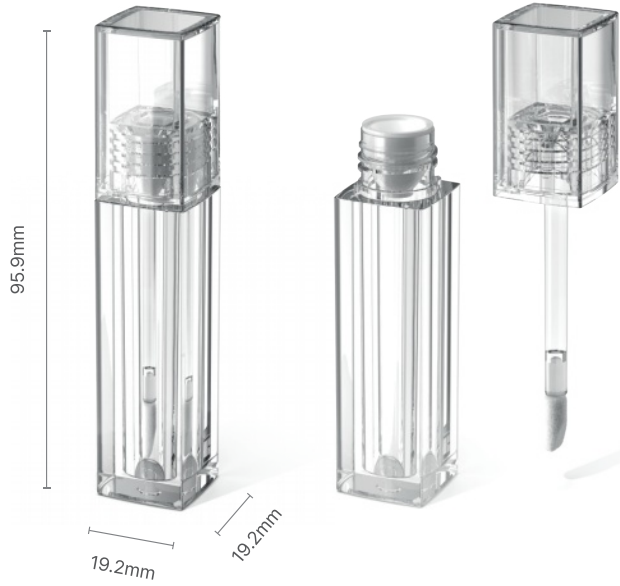

SHT-38

SIZE 15.2mm x 15.2mm x 69.4mm
VOLUME 2ml
MATERIALS PETG



SHT-39

SIZE 18.2mm x 18.2mm x 94.5mm
VOLUME 4ml
MATERIALS PETG

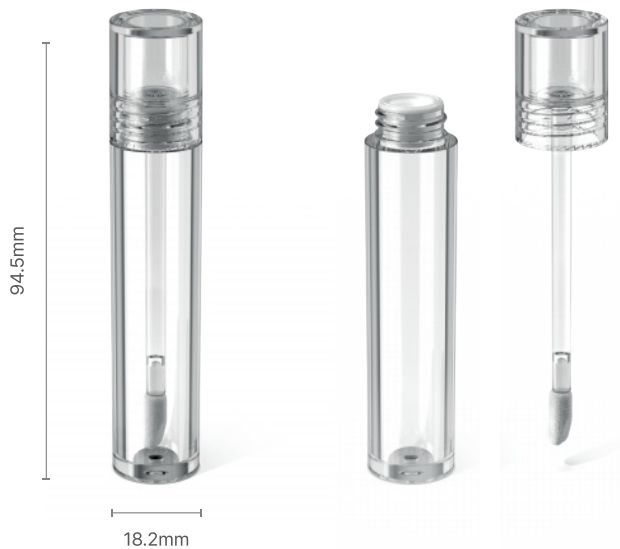

SHT-40

SIZE 19.2mm x 19.2mm x 95mm
VOLUME 4ml
MATERIALS PETG

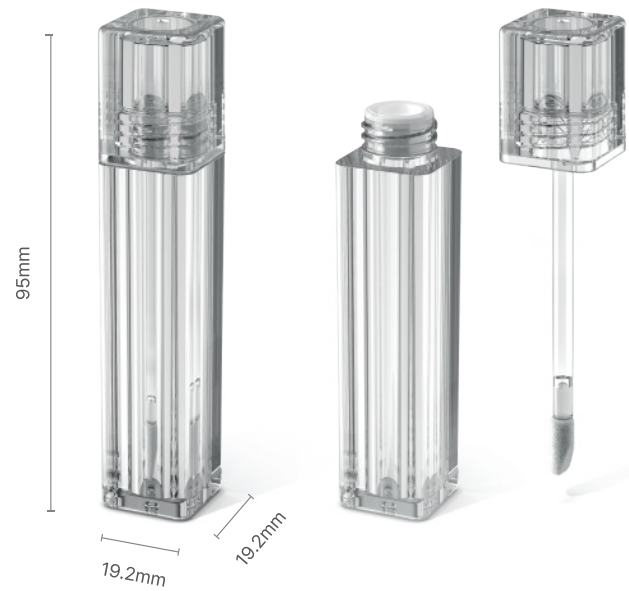
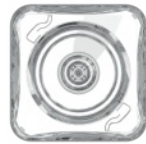

SHT-41

SIZE 18.1mm x 18.1mm x 97mm
VOLUME 5ml
MATERIALS PETG

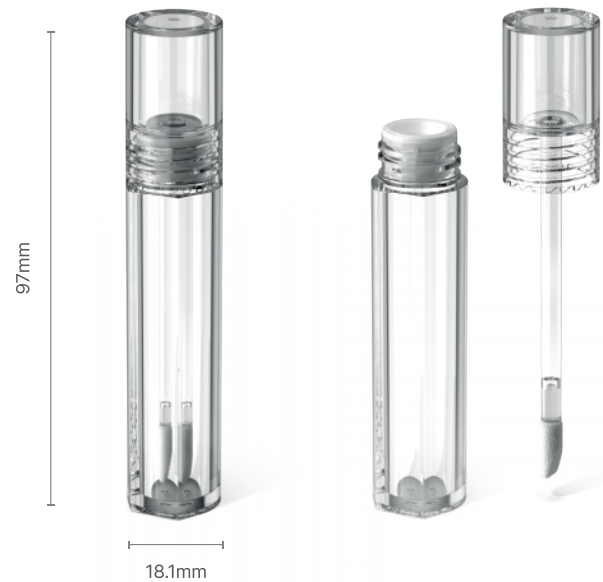

SHT-42

SIZE 19.8mm x 17.7mm x 100.3mm
VOLUME 5ml
MATERIALS PETG

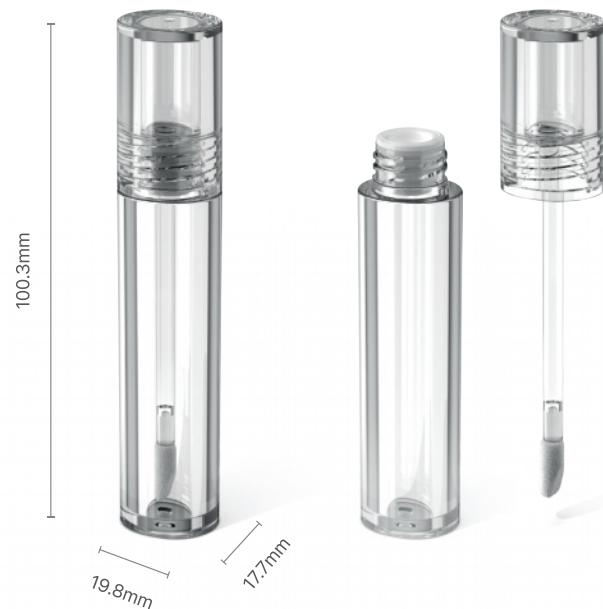

SHT-43

SIZE 18.5mm x 18.5mm x 99.9mm
VOLUME 5ml
MATERIALS PETG

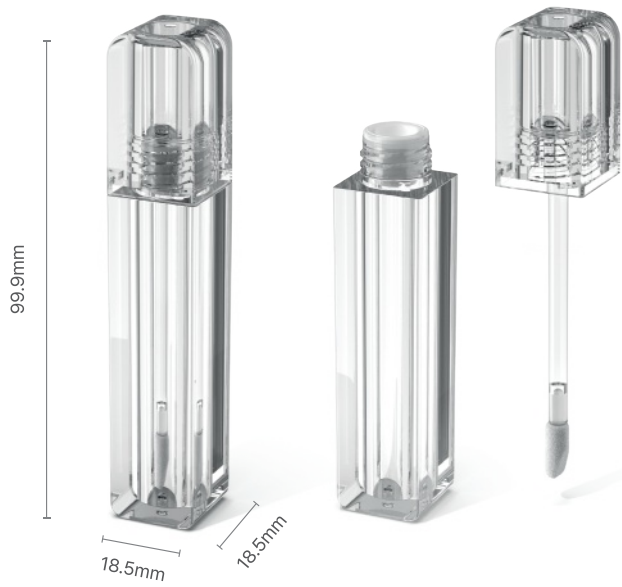

SHT-44

SIZE 17.7mm x 17.7mm x 97.3mm
VOLUME 4ml
MATERIALS PETG

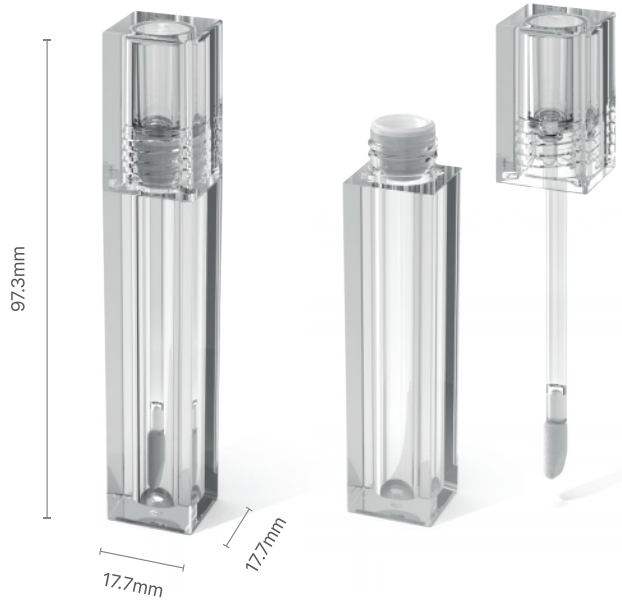

SHT-45

SIZE 19.3mm x 19.3mm x 97mm
VOLUME 4ml
MATERIALS PETG



SHT-46

SIZE 18.8mm x 18.3mm x 97.2mm
VOLUME 4ml
MATERIALS PETG

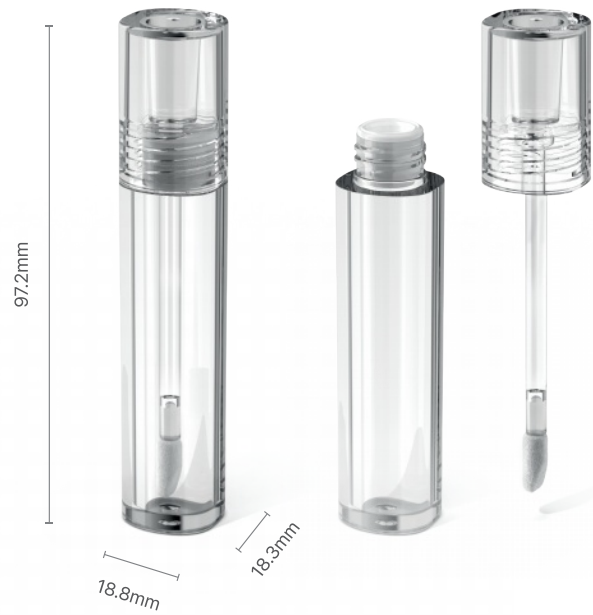

SHT-47

SIZE 18.1mm x 18.1mm x 94.8mm
VOLUME 4ml
MATERIALS PETG

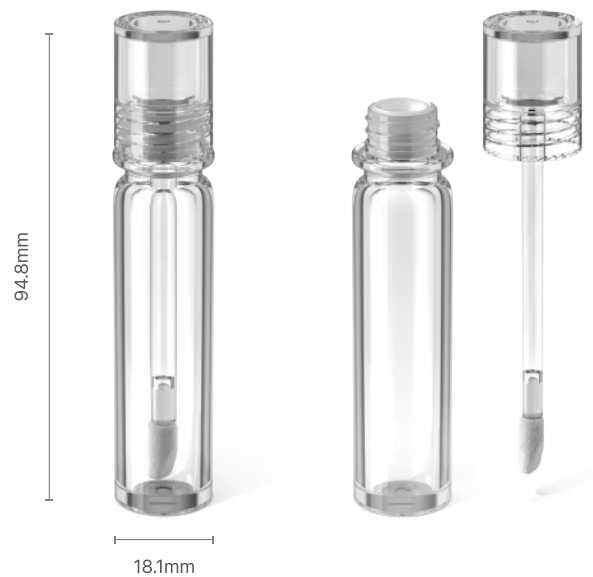

SHT-48

SIZE 18.4mm x 18.4mm x 98.1mm
VOLUME 5ml
MATERIALS PETG

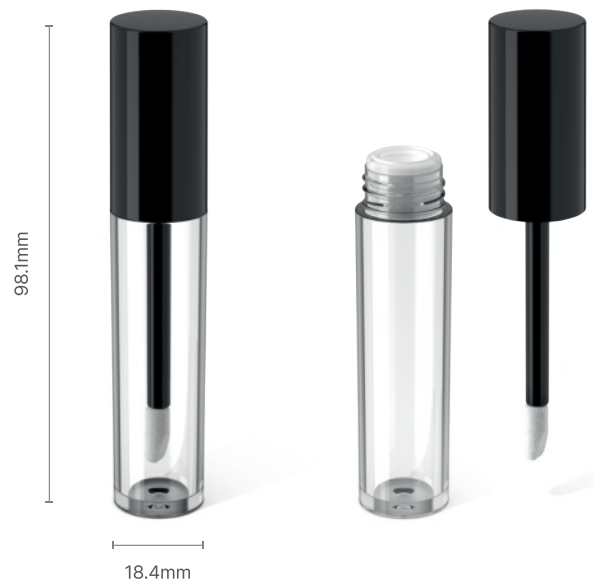

SHT-49

SIZE 18.4mm x 18.4mm x 100.3mm
VOLUME 7ml
MATERIALS PETG



SHT-50

SIZE 20.1mm x 18mm x 97mm
VOLUME 4ml
MATERIALS PETG

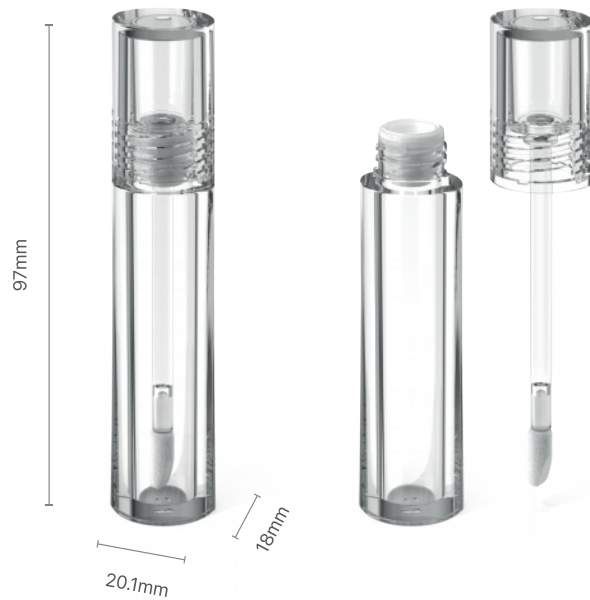

SHT-51

SIZE 19.3mm x 19.3mm x 92.5mm
VOLUME 4.5ml
MATERIALS PETG

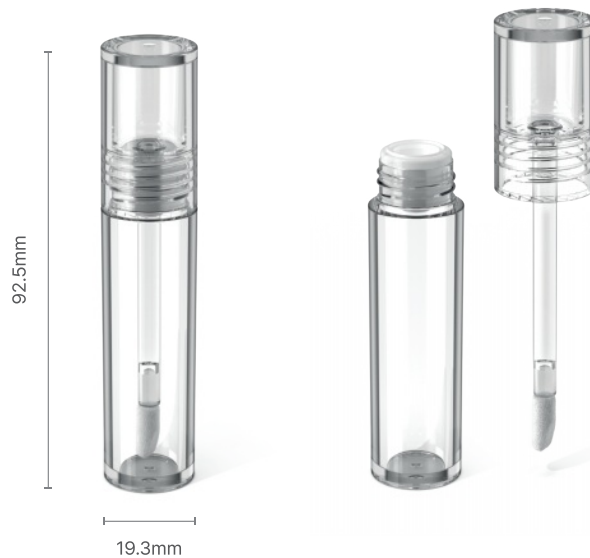

SHT-51-01

SIZE 19.6mm x 19.6mm x 87.5mm
VOLUME 4ml
MATERIALS PETG



SHT-52

SIZE 20.7mm x 20.7mm x 82.8mm
VOLUME 4.5ml
MATERIALS PETG



SHT-53

SIZE 26mm x 21mm x 73.3mm
VOLUME 5ml
MATERIALS PETG

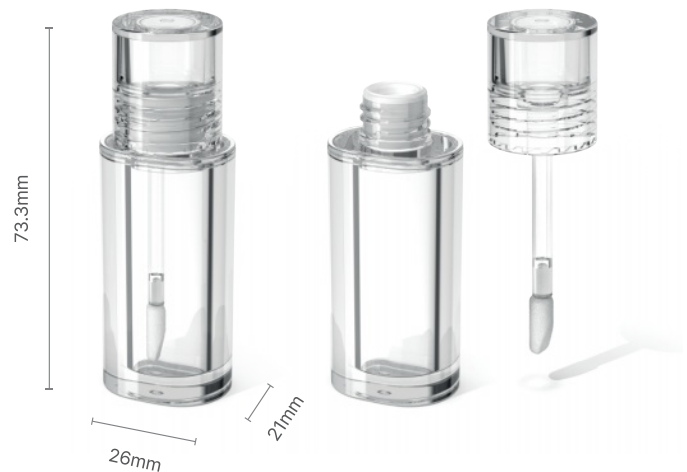

SHT-54

SIZE 23.4mm x 23.4mm x 80.2mm
VOLUME 4.5ml
MATERIALS PETG



SHT-55

SIZE 17.2mm x 17.2mm x 93.3mm
VOLUME 4ml
MATERIALS PETG

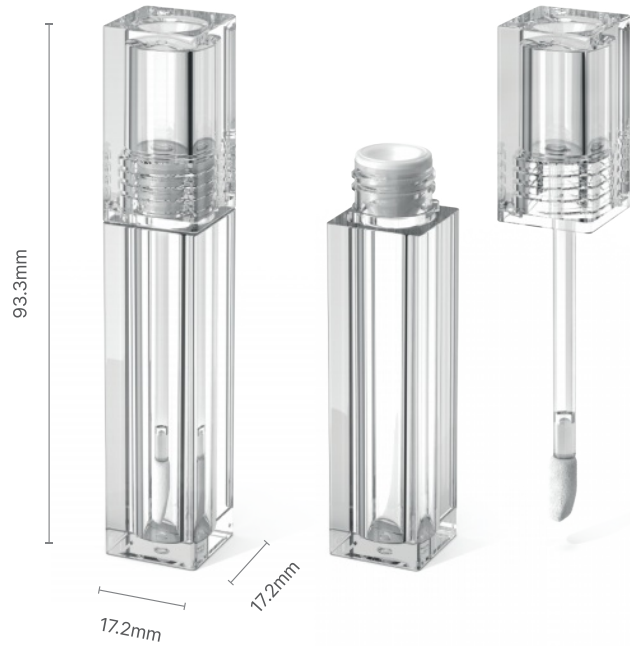

SHT-56

SIZE 22.2mm x 19mm x 100.1mm
VOLUME 5ml
MATERIALS PETG



SHK-01

SIZE 21.6mm x 21.6mm x 74mm
VOLUME 4ml
MATERIALS PETG



SHD-01

SIZE 38.5mm x 38.5mm x 16.4mm
VOLUME 2g
MATERIALS ABS, SAN



SHD-02

SIZE 51mm x 51mm x 18.7mm
VOLUME 2.5g
MATERIALS ABS, SAN



SHD-03

SIZE 59.9mm x 59.9mm x 17.2mm
VOLUME 5g
MATERIALS ABS, SAN



SHD-04

SIZE	51mm x 51mm x 15.5mm
VOLUME	4g
MATERIALS	ABS, SAN



SHD-05

SIZE	50.1mm x 50.1mm x 17.2mm
VOLUME	4g
MATERIALS	ABS, SAN

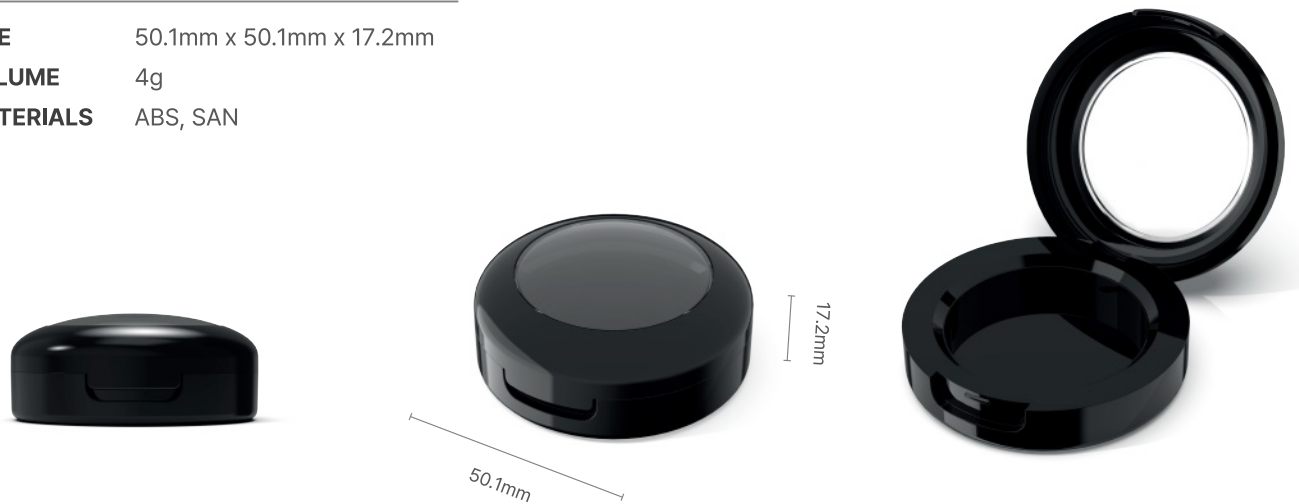

SHD-06

SIZE	49.3mm x 49.3mm x 13.8mm
VOLUME	4g
MATERIALS	PMMA

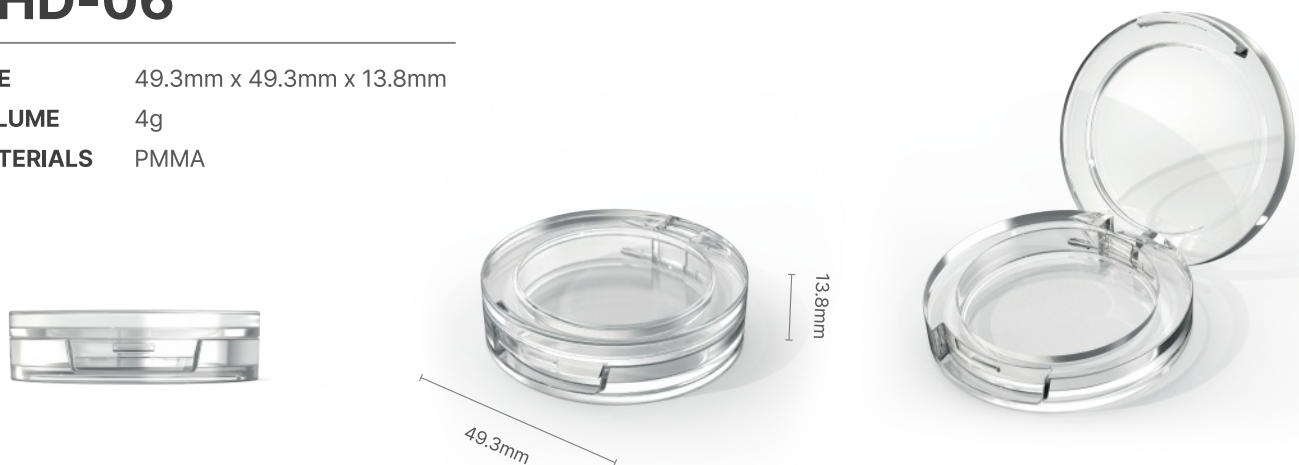

SHD-07

SIZE 57mm x 57mm x 13.8mm
VOLUME 8g
MATERIALS PMMA

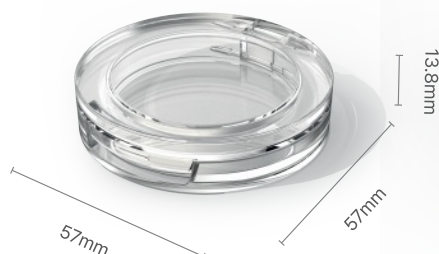

SHD-08

SIZE 41.5mm x 41.5mm x 15.2mm
VOLUME 3g
MATERIALS ABS, PMMA

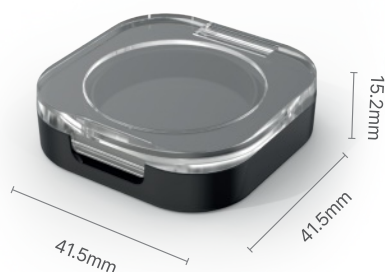

SHD-09

SIZE 42mm x 42mm x 9.8mm
VOLUME 3g
MATERIALS PMMA



SHD-10

SIZE 42mm x 42mm x 9.5mm
VOLUME 4g
MATERIALS PMMA

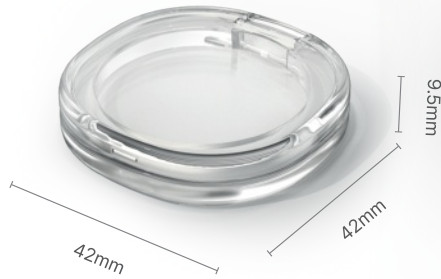

SHD-11

SIZE 39.8mm x 39.8mm x 17.9mm
VOLUME 1g
MATERIALS ABS



SHD-11-01

SIZE 39.8mm x 39.8mm x 24.5mm
VOLUME 2g
MATERIALS ABS



SHD-12

SIZE 49.8mm x 49.8mm x 13mm
VOLUME 3.5g
MATERIALS ABS



SHD-12-01

SIZE 49.8mm x 49.8mm x 19.9mm
VOLUME 7g
MATERIALS ABS



SHD-13

SIZE 71.8mm x 71.8mm x 24.1mm
VOLUME 6g
MATERIALS ABS, SAN



SHD-14

SIZE 55.8mm x 69mm x 8mm
VOLUME 5g
MATERIALS PMMA



SHD-15

SIZE 55.8mm x 69mm x 8mm
VOLUME 5g
MATERIALS PMMA

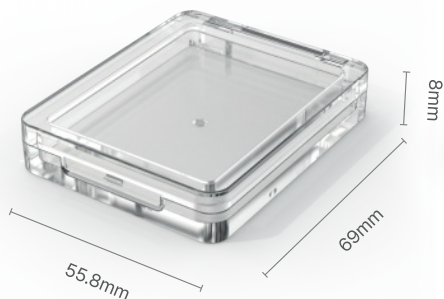

SHD-16

SIZE 55.8mm x 69mm x 8mm
VOLUME 5g
MATERIALS PMMA

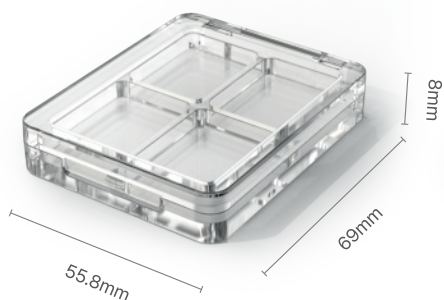

SHD-17

SIZE 38.2mm x 38.2mm x 10.1mm
VOLUME 1g
MATERIALS PMMA

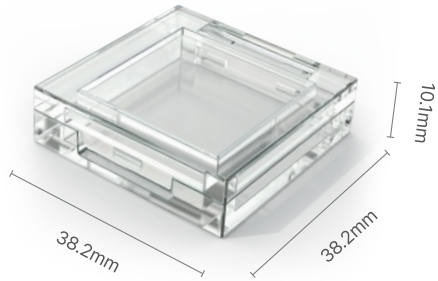

SHD-18

SIZE 50.2mm x 50.2mm x 11.4mm
VOLUME 3g
MATERIALS PMMA

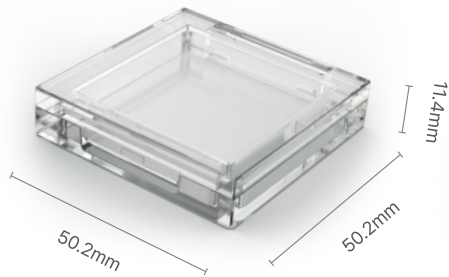

SHD-19

SIZE 70.1mm x 70.1mm x 10.3mm
VOLUME 5g
MATERIALS PMMA

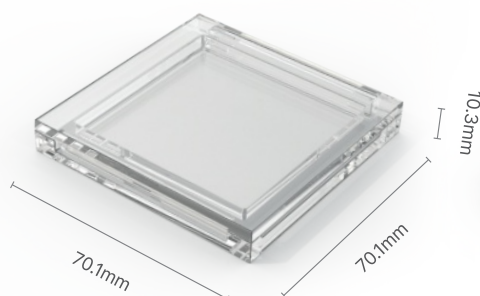

SHD-20

SIZE	76.1mm x 76.6mm x 13.4mm
VOLUME	8g
MATERIALS	PMMA

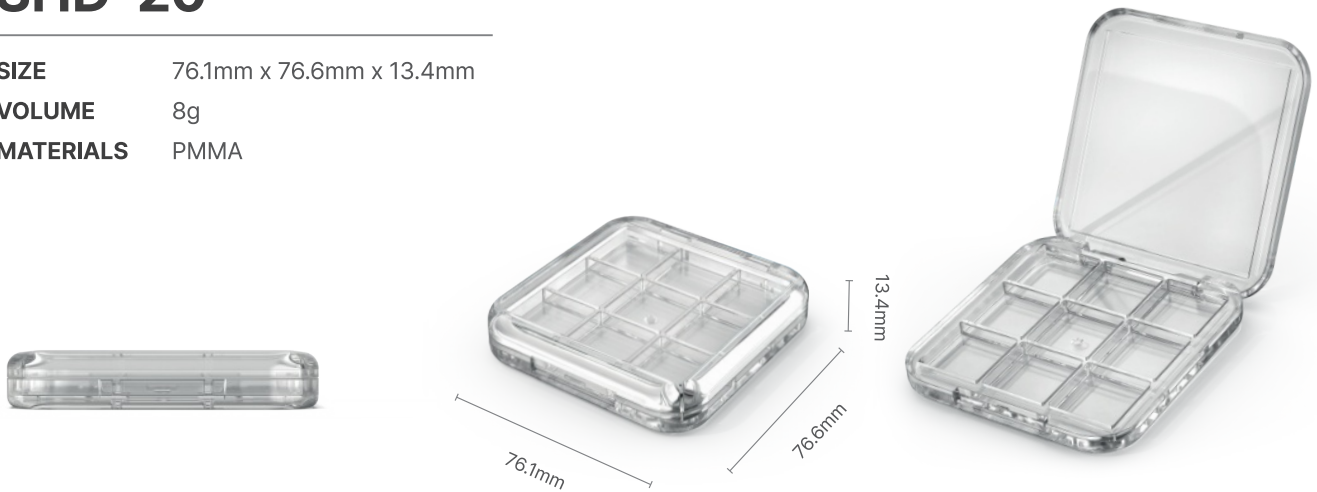

SHD-21

SIZE	76mm x 56.4mm x 13.6mm
VOLUME	5.5g
MATERIALS	PMMA

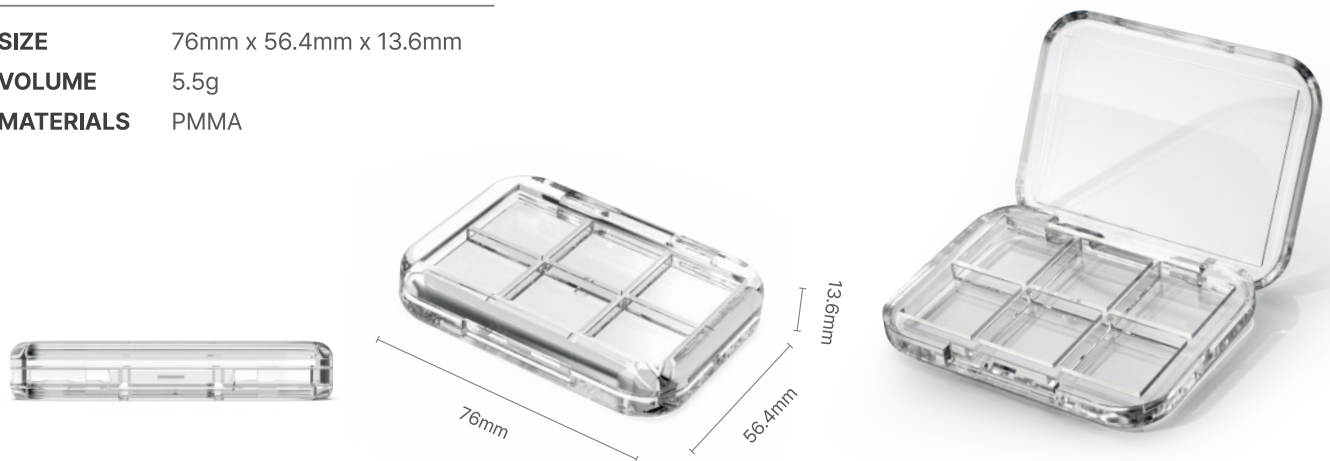

SHD-22

SIZE	56.4mm x 76mm x 13.6mm
VOLUME	5.5g
MATERIALS	PMMA

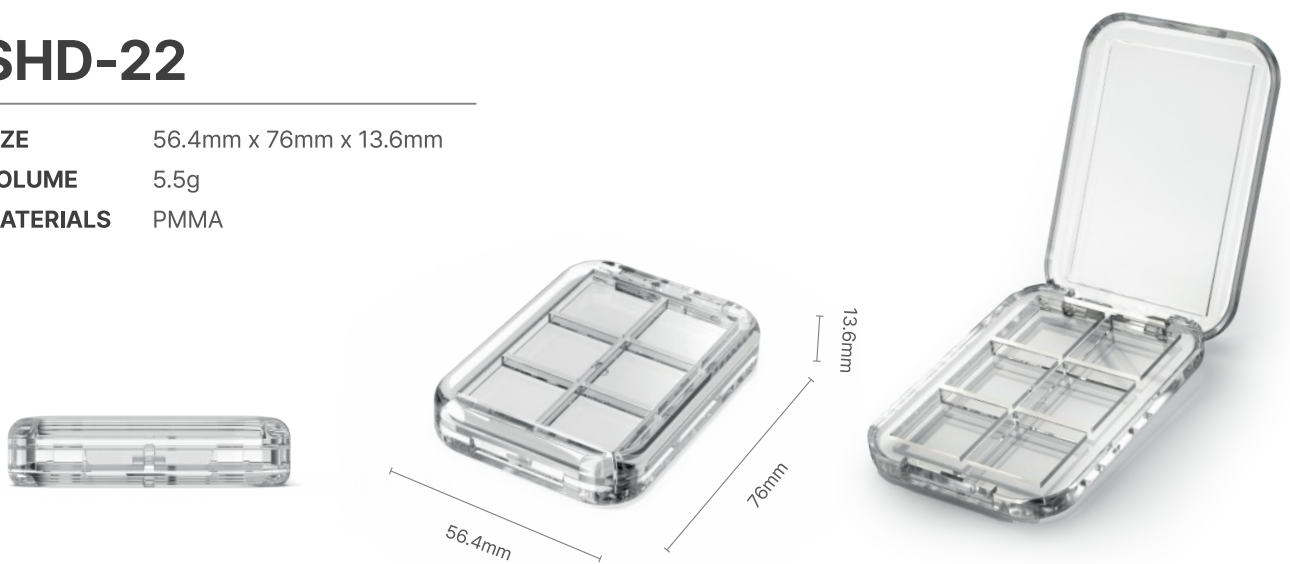

SHR-02

SIZE 33.8mm x 33.8mm x 119.2mm
VOLUME 30ml
MATERIALS ABS, PETG



